



XEON

Luminaire design: Eclatec

XEON is above all a range of architectural projectors with outstanding performance; **XEON** also means a wide range of options and features that meet the diverse needs of urban developers:

- **Lighting and illumination**, of course, in roadway applications, for parks and gardens or in heritage building enhancement, with an extensive choice of colour temperatures or colour changing (**RGBW**),
- **Projection** of images, logos, photos and texts, in different sizes and on various types of surfaces, in black and white or in colour, using **GOBO** devices,
- **CCTV**, via a discrete fixed camera solution totally integrated into the projector, or using a dissuasive and visible solution with a PTZ mobile camera,
- **Sound**, intended for public places, using integrated loudspeakers,

XEON luminaires are available in three sizes; they are equipped with multi-directional ball joints concealing the wiring. This feature promotes discreet, elegant and effective integration into various structures, including needle masts and high-rise facilities.





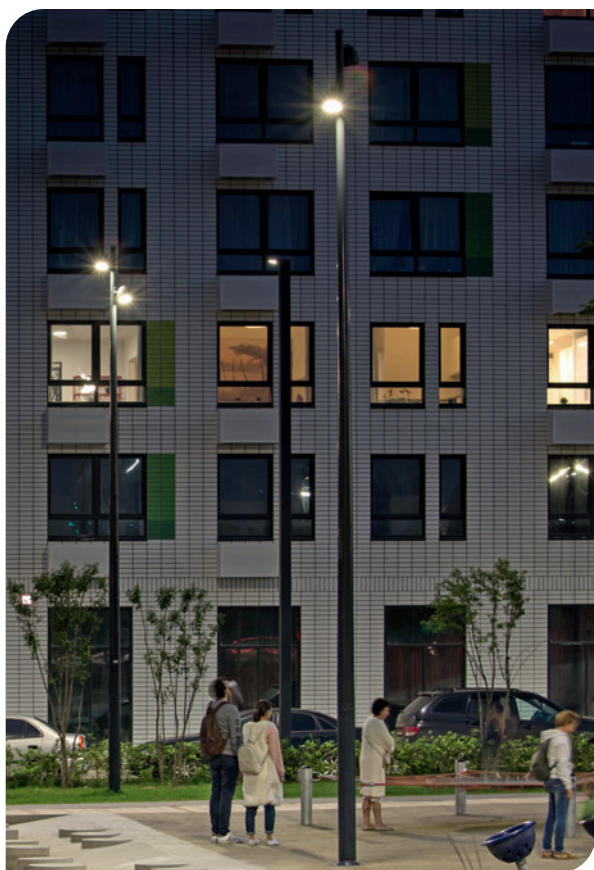
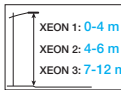

XEON 1



XEON 2



XEON 3



DESCRIPTION

- Injected cast aluminium body, module and mechanical interfaces
- Thermally tempered glass
- Finish in polyester powder coating, in a choice of colours
- IP 66
- XEON 1: IK 09, XEON 2 and 3: IK 10
- Class I or II
- Pre-wired flexible cable
- RoHS compliant
- High recyclability rate

DIMENSIONS

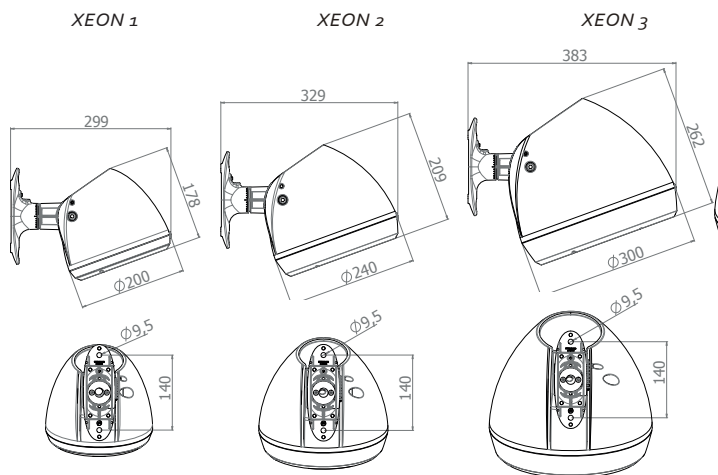

WATERTIGHTNESS

- IP 66 ingress protection
- Extruded silicon joint
- Cable gland
- Light ventilation through active charcoal filter

MECHANICAL INTERFACES

- Attachment for conical or cylindro-conical pole{1}

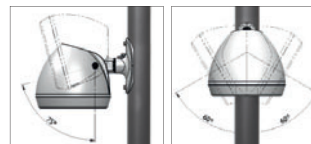

- Inclinations:
 - Position indicators in increments of 5°
 - Adjustment on the horizontal plane: -60° to +60° with end stop, screw lock
 - Max. adjustment on the vertical plane: 0° to +75°, screw lock

- Wall light via specific slider {2}

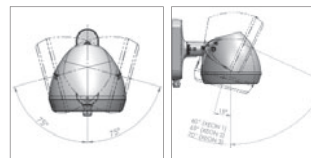

- Inclinations:
 - Adjustment in the horizontal plane: -75° to +75° (illumination upward or downward), ATTENTION graduations range only from -40° to +40° with limit stop, locked by screw - Max adjustment in the vertical plane: -15° to +60° for XEON 1 / +65° for XEON 2 / +70° for XEON 3 locked by screw

- Lateral bracket attachment {3}



KEY POINTS

		XEON 1	XEON 2	XEON 3
Mounting		See mechanical interfaces		
Dimensions	Ø	200 mm	240 mm	300 mm
	height	178 mm	209 mm	262 mm
Weight		3.3 kg	3.9 kg	5.5 kg
Windage area		0.03 m ²	0.04 m ²	0.06 m ²
Sources		COB	XEON	
Colour temperature		3000 K or 4000 K		
Sources access		Removable LED module		
Optics and light distribution options		UNILENS	ORALENS	
		PFI, PFM and PFL	PFI, PFM, PFL, ERS, ERL	PFM, PFL, ERS, ERL
OPTIONS	SMART-READY® (1) by Eclatec (construction)	-	○	○
	DALI (construction)	○	○	○
	Dimming 5 (preset)	○	○	○
	CLO (preset)	Compatible with standard version, Dimming 5 and DALI option		
	Motion COM (setting on site)	○	○	○
	Motion P (set in the bottom of the pole)	○	○	○
	POLEDRIVE (set in the bottom of the pole)	○	○	○

(1) Communicating system pre-configuration: wired Sensor Ready type driver and base in accordance with Zhaga consortium

Glossary:

● Standard ○ Option - Not available

E/L/P: Lighting/Luminance/Projection, **R/C/T/F/P:** Road/Circulation/Path/Beam/Pedestrian walkway, **E/S/L/A/D/G:** Narrow/Standard/Wide/Asymmetric/Right/Left, **POLEDRIVE:** preset at the bottom of the pole / night dimming calculator with 2 configurable thresholds, set in the bottom of the pole, **Dimming 5:** night dimming calculator with 5 configurable thresholds, **Motion:** moving sensor, **Motion P:** Configurable offset presence detector at the foot of the pole, **Motion DALI:** Detector integrated to the luminaire, adjustable at pole base, **Motion 5:** Motion sensor and dimming calculator, **Motion COM:** Wireless detection and communication, **DALI:** compatible with the DALI protocol, **CLO:** Constant Lumen Output option

OPTIONS

• Visor, canon, anti-glare grill and diffusing glass options



• Camera: fixed or with movement, loudspeaker, GOBO and RGBW options



PHOTOMETRIC DISTRIBUTIONS

XEON 2 and 3 - ERL

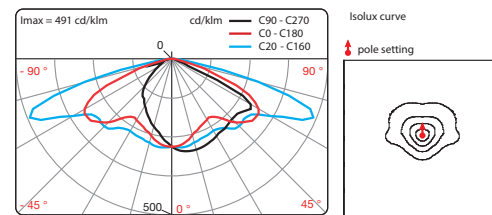

XEON 2 and 3 - ERS

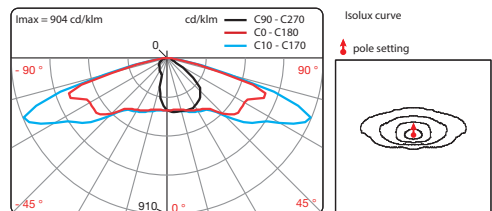

	XEON 1	XEON 2	XEON 3 (2)
Max. power ⁽¹⁾ (W)	32	50	73
Max. output 4000K ⁽¹⁾ (lm)	2200	5722	8292
Max. output 3000K ⁽¹⁾ (lm)	1980	5185	7514

(1) Total power consumed by the lighting including all electrical equipment, including the power supply, and output from the lighting at commissioning (including the thermal and optical efficiencies with respect to the input power) for a given electrical network, maximum intensity and ambient temperature of 25°C, in accordance with IEC 62717 and IEC 62722 performance standards

(2) Also available in 100W discharge source.

Non-contractual data

XEON - PFI

Imax = 14180 cd/klm
1/2 Opening angle at Imax/2 (°) = 5,5

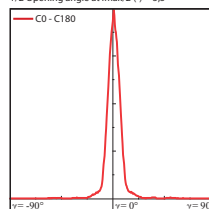

XEON - PFM

Imax = 6160 cd/klm
1/2 Opening angle at Imax/2 (°) = 9,5

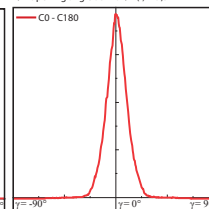

XEON - PFL

Imax = 913 cd/klm
1/2 Opening angle at Imax/2 (°) = 30

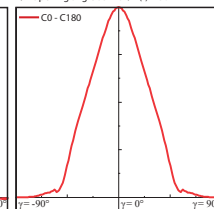

MAINTENANCE

Maintenance of equipment and sources

Projector opening with 3 captive screws (safety wire)
Rapid electrical disconnection without tools
Removable LED module on site

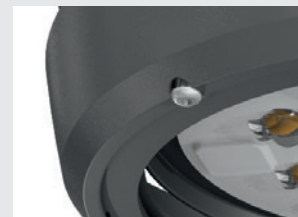

XEON - RGBW



XEON RGBW

- All three sizes of the XEON luminaire are available as an RGBW option
- Applications: heritage building enhancement, illumination, visual accentuation
- Static colours: monochromatic lights, red, green, blue, white and combinations of these four colours
- Dynamic colours: chromatic variations
- Control by DMX protocol (DALI protocol on request)
- Optional programming of the driver, for fixed colours or chromatic variations, using a programming module
- Prewiring of DMX in the factory

XEON 1

XEON 2

XEON 3

Intensity (mA)	700		700		350	
Lenses and distributions	PFL (Aperture at $I_{max}/2 = 36^\circ$) and PFM Aperture at $I_{max}/2 = 22^\circ$)		PFI with 10° diffuser or 30° diffuser		PFI with 10° diffuser or 30° diffuser	
Colour	Outgoing flow (lm)	Power (W)	Outgoing flow (lm)	Power (W)	Outgoing flow (lm)	Power (W)
Red	160	10	650	15	490	11
Green	360	11	940	18	710	13.5
Blue	85	11.5	235	18	180	13.5
White	590	11	925	18	700	13.5

PFI/I-M-L: Beam projection/ Intensive-Medium-Large

CCTV

XEON - Cameras



Fixed camera

Camera with movement

XEON 2 and 3 can integrate **CCTV** cameras, connected by Web browser, which operate day and night.

TWO TYPES OF CAMERAS ARE AVAILABLE

Fixed camera

A discreet solution, with a fixed SAMSUNG camera entirely integrated into the projector and three compatible lenses according to the installation height, the field of view and the area of coverage.

Camera with movement

A dissuasive and visible solution, with an AXIS PTZ camera offering panoramic vision and the possibility of horizontal and vertical movement, allowing objects to be tracked on the move.

CHARACTERISTICS

- Compatible with the protocol defined by ONVIF (open protocol: Open Network Video Interface Forum) and therefore compatible with most security systems
- Internet connection allowing viewing from a control station
- Full HD resolution 1920x1080
- Digital zoom
- Optimization of image quality
- Local recording possible on SD card

- PoE or DC power supply
- Detection features
- IP 66
- IK 10
- Working temperature: -20°C to $+50^\circ\text{C}$
- Power: 8 to 10W
- Dimensions and mechanical interfaces: refer to chapter LIGHTING

SOUND

XEON - Loudspeaker



XEON 2 and 3 can integrate a **loudspeaker** allowing voice messages, information or music to be broadcast. This 100 V analog sound system is connected to an on-site audio amplifier, which provides power directly to the speaker. The audio amplifier is also connected to the audio source.

CHARACTERISTICS

- Finish in polyester powder coating, in a choice of colours
- 100 V loudspeaker
- 92 dB, internal acoustic foam
- Multiple input impedance transformer
- Wide band without acute section
- HP IP44 weather resistant
- Power adjustable from 2.5 à 15 W
- Dimensions and mechanical interfaces: refer to chapter LIGHTING

XEON 3 can integrate a **GOBO** projector capable of projecting monochrome or multicolored black and white images or messages up to 12 m. In order to provide maximum resolution, the optics of GOBOs projectors are made of dichroic glass, allowing superior flexibility of colours and light effects, including metallic or pastel colours (metallic GOBOs available).

In addition, the 5500K LED source with IRC 80 provides crisp, clear projection with perfect colour rendering, regardless of the surrounding environment.

XEON 3 - GOBO



DESCRIPTION

- Injection cast aluminium body, module and mechanical interfaces
- Heat-tempered and screen-printed glass bowl
- Finish in polyester powder coating, in a choice of colours
- Power 34 W
- IP 66
- IK 10
- 6.8 kg – SCx 0.06 m²
- Class I only
- Pre-wired in the factory
- Dimensions and mechanical interfaces: refer to chapter LIGHTING

CHOICE OF LENS

Three lenses allow a great diversity between the size of the projected graphics and the projection distance.

In general, for the same projection distance, the larger the angle of opening, the larger the projected area, and the less bright the projected image.

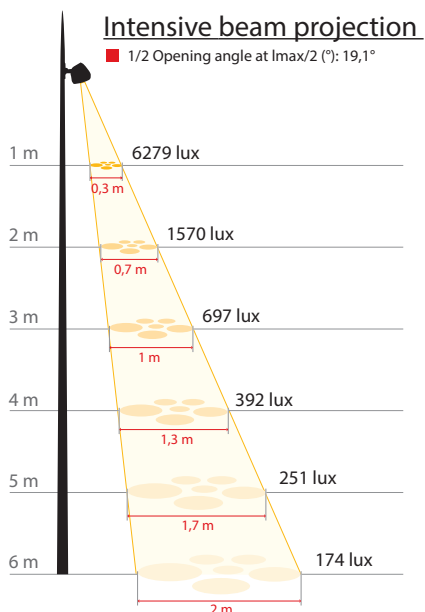

The illumination data are only indicative and not contractual.

INSTALLING/ CHANGING THE GOBO

- Open the XEON via the three captive screws on the front panel to access the internal projector
- Easy installation of the GOBO in the projector following instructions
- Adjust the focus by turning the lens (by first unscrewing the locking screw, and tightening it after adjustment)

RENDERINGS, EFFECTS AND PATTERNS

A large library of figurative GOBO patterns such as foliage or clouds, as well as abstract patterns, are available on request.

ECLATEC can also create **personalized patterns** on any theme, or using a photo, as requested by the customer.



- **In steel:** Disk cut to pattern, logo, with text required. This is the least expensive solution for colourless projection.

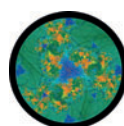

- **In glass:** The colored GOBOs are formed by superimposing layers of dichroic glass with engraved shapes, to mix the colours necessary for the image by subtraction. These custom glass GOBOs are ultra-thin (1.1mm thick for monochrome and black and white models, and 1.9mm for multicolored models), providing excellent image projection.

The pattern to be projected must be provided in a vector format, in order to be transcribed on the GOBO. ECLATEC can convert your computer files into this format.

EXAMPLES OF USES



Projection of patterns on the ground

LED Luminaires

Modern Streetfurniture

Waste bins

Bollards Light

tree grill

Bollards

Classic poles cast iron

Steel poles

MODERN POLES CAST IRON

Defence bollards

Drinking water fountain

SEATING

TRAMWAY POLES

Modern LED luminaires

Classic luminaires

Classic street furniture

Ghm

Rue Antoine Durenne
52220 Sommevoire
France
Tel nr. 0033 3 25 55 23 03

ECLATEC

41 rue Lafayette
54320 Maxeville
France
Tel nr. 0033 3 83 39 38 28

Export internet : www.ghm-eclatec.com

Email export: info@ghm-eclatec.com